



General Description

AFP1013, P-Channel enhancement mode MOSFET, uses Advanced Trench Technology to provide excellent $R_{DS(ON)}$, low gate charge.

These devices are particularly suited for low voltage power management, such as smart phone and notebook computer, and low in-line power loss are needed in commercial industrial surface mount applications.

Features

- -20V/-0.6A, $R_{DS(ON)} = 620 \text{ m}\Omega @ V_{GS} = -4.5\text{V}$
- -20V/-0.5A, $R_{DS(ON)} = 860 \text{ m}\Omega @ V_{GS} = -2.5\text{V}$
- -20V/-0.4A, $R_{DS(ON)} = 1450 \text{ m}\Omega @ V_{GS} = -1.8\text{V}$
- Low Offset (Error) Voltage
- Low-Voltage Operation
- High-Speed Circuits
- Low Battery Voltage Operation
- SOT-523 package design

Pin Description (SOT-523)

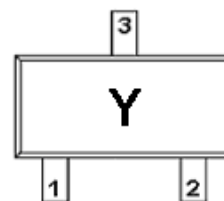
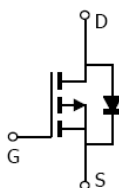
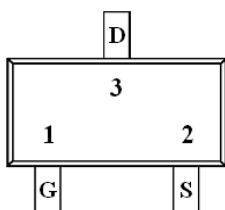

Application

- Drivers: Relays, Solenoids, Lamps, Hammers, Displays, Memories
- Battery Operated Systems
- Power Supply Converter Circuits
- Load/Power Switching Smart Phones, Pagers

Pin Define

Pin	Symbol	Description
1	G	Gate
2	S	Source
3	D	Drain

Ordering Information

Part Ordering No.	Part Marking	Package	Unit	Quantity
AFP1013S52RG	Y	SOT-523	Tape & Reel	3000 EA

※ AFP1013S52RG : 7" Tape & Reel ; Pb- Free ; Halogen- Free



Absolute Maximum Ratings

(T_A=25°C Unless otherwise noted)

Parameter	Symbol	Typical	Unit
Drain-Source Voltage	V _{DSS}	-20	V
Gate –Source Voltage	V _{GSS}	±12	V
Continuous Drain Current(T _J =150°C)	I _D	T _A =25°C	-0.7
		T _A =70°C	-0.4
Pulsed Drain Current	I _{DM}	-1.0	A
Continuous Source Current(Diode Conduction)	I _S	-0.3	A
Power Dissipation	P _D	T _A =25°C	0.27
		T _A =70°C	0.16
Operating Junction Temperature	T _J	-55/150	°C
Storage Temperature Range	T _{STG}	-55/150	°C

Electrical Characteristics

(T_A=25°C Unless otherwise noted)

Parameter	Symbol	Conditions	Min.	Typ	Max.	Unit
Static						
Drain-Source Breakdown Voltage	V _{(BR)DSS}	V _{GS} =0V, I _D =-250uA	-20			V
Gate Threshold Voltage	V _{GS(th)}	V _{DS} =V _{GS} , I _D =-250uA	-0.4		-1.0	
Gate Leakage Current	I _{GSS}	V _{DS} =0V, V _{GS} =±12V			±100	nA
Zero Gate Voltage Drain Current	I _{DSS}	V _{DS} =-20V, V _{GS} =0V			-1	
		V _{DS} =-20V, V _{GS} =0V T _J =85°C			-5	uA
On-State Drain Current	I _{D(on)}	V _{DS} ≥ 5V, V _{GS} =4.5V	0.7			A
Drain-Source On-Resistance	R _{DS(on)}	V _{GS} =-4.5V, I _D =-0.6A		500	620	
		V _{GS} =-2.5V, I _D =-0.5A		700	860	
		V _{GS} =-1.8V, I _D =-0.4A		1000	1450	
Forward Transconductance	g _{FS}	V _{DS} =-10V, I _D =-0.4A		1		S
Diode Forward Voltage	V _{SD}	I _S =-0.15A, V _{GS} =0V		0.65	1.2	V
Dynamic						
Input Capacitance	C _{iss}	V _{DS} =-10V, V _{GS} =0V f=1MHz		70	100	pF
Output Capacitance	C _{oss}			20		
Reverse Transfer Capacitance	C _{rss}			10		
Total Gate Charge	Q _g	V _{DS} =-10V, V _{GS} =-4.5V I _D ≡-0.25A		1.0	1.3	nC
Gate-Source Charge	Q _{gs}			0.1		
Gate-Drain Charge	Q _{gd}			0.3		
Turn-On Time	t _{d(on)}	V _{DD} =-10V, R _L =30Ω I _D ≡-0.2A, V _{GEN} =-4.5V R _G =10Ω		10	15	ns
	t _r			10	15	
Turn-Off Time	t _{d(off)}			40	60	
	t _f			30	50	



Typical Characteristics

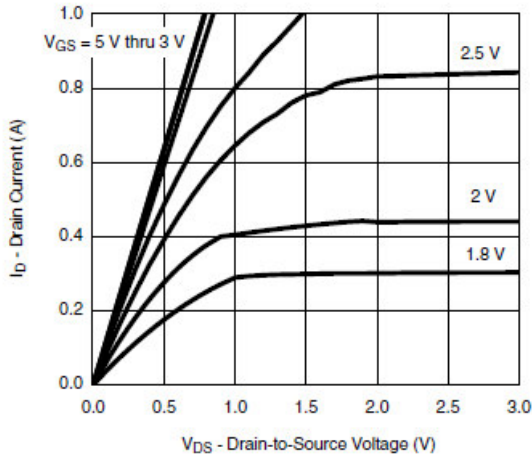

Output Characteristics

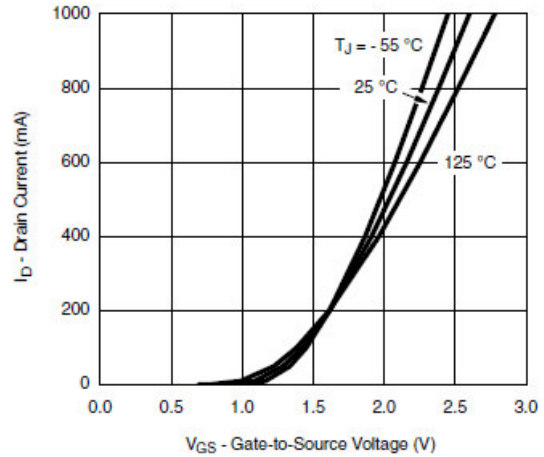

Transfer Characteristics

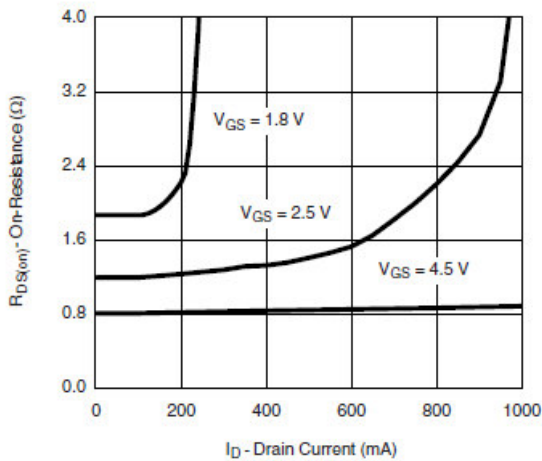

On-Resistance vs. Drain Current

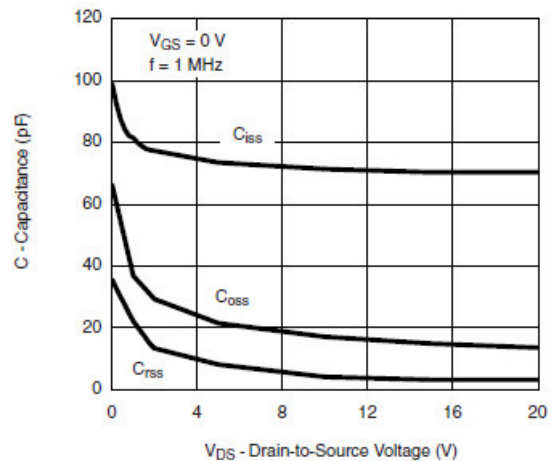

Capacitance

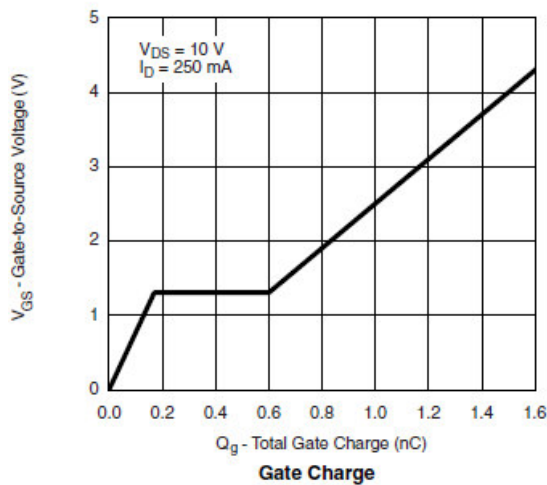

Gate Charge

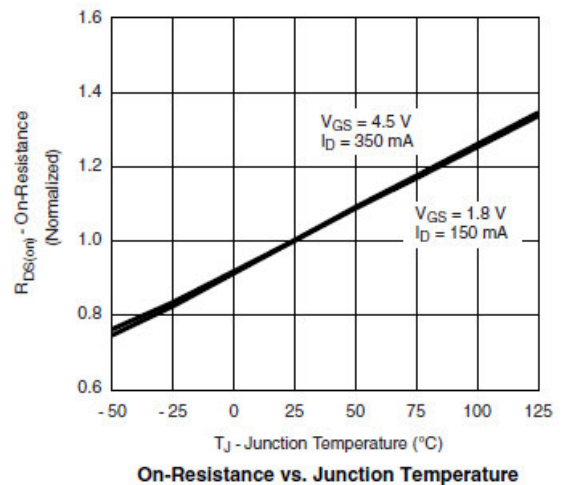

On-Resistance vs. Junction Temperature



Typical Characteristics

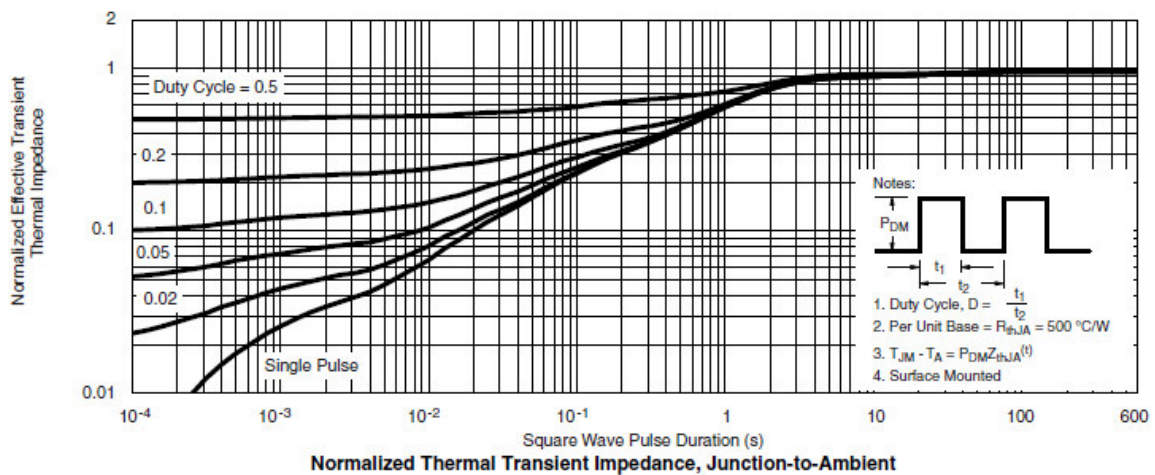
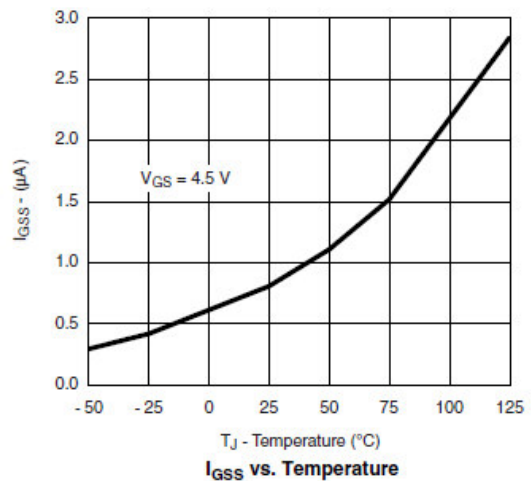
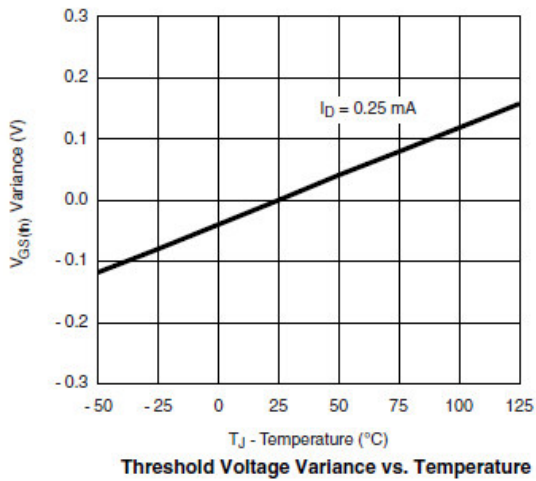
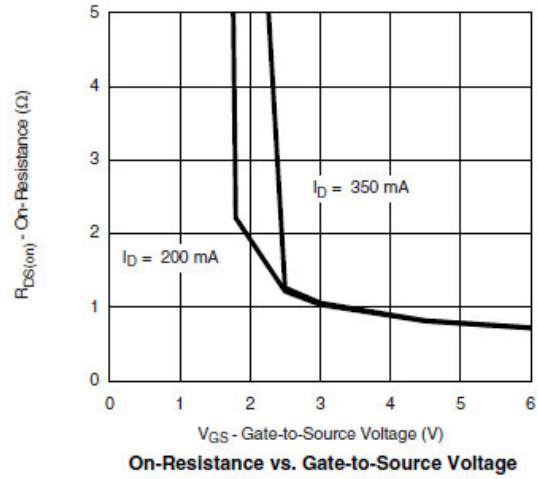
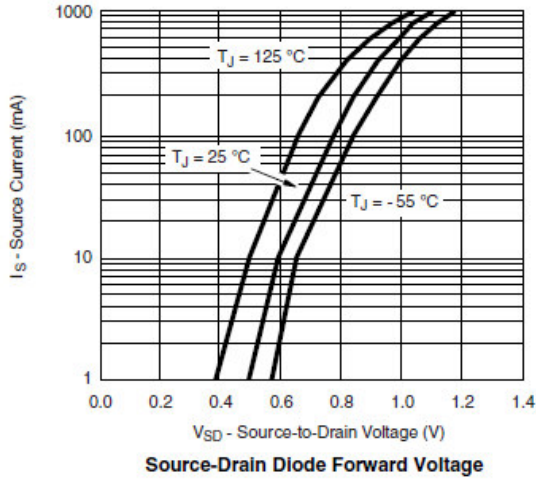



Typical Characteristics

Gate Charge Test Circuit & Waveform

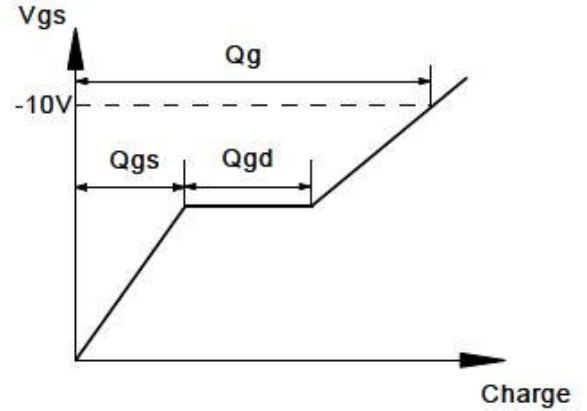
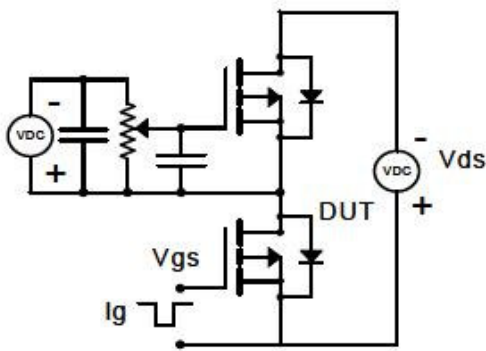

Resistive Switching Test Circuit & Waveforms

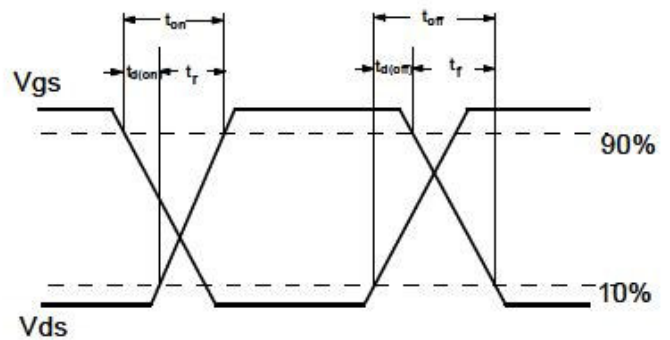
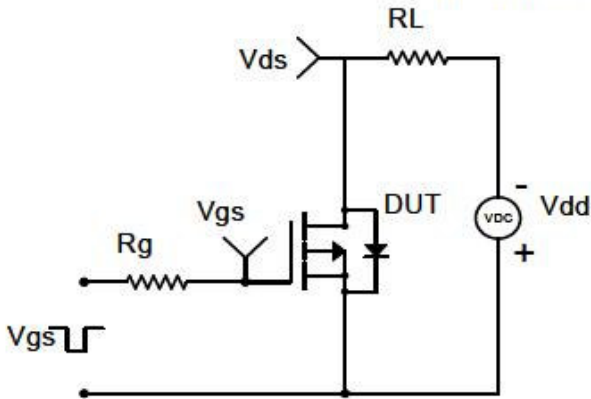

Diode Recovery Test Circuit & Waveforms

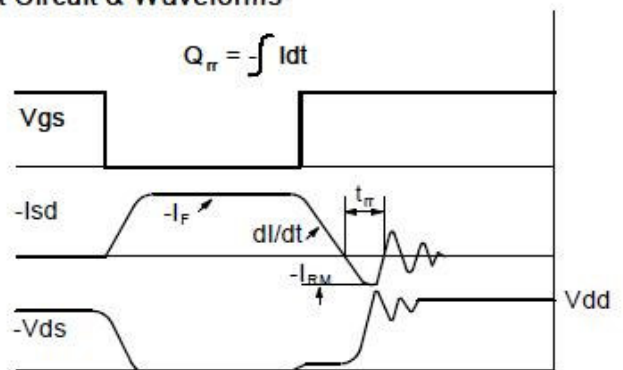
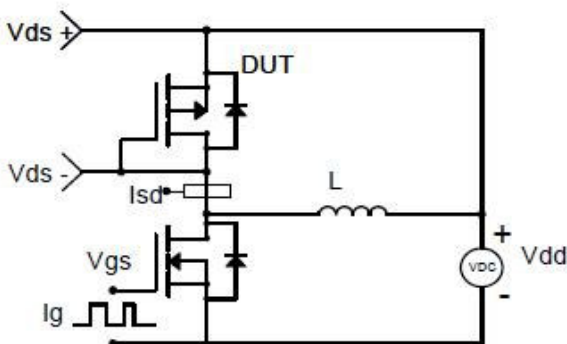



Package Information (SOT-523)

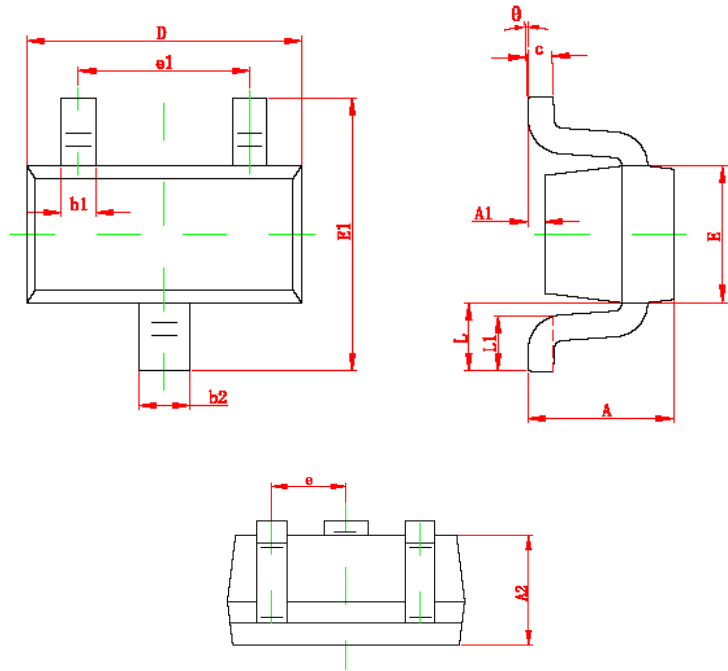

Symbol	Dimensions In Millimeters		Dimensions In Inches	
	Min	Max	Min	Max
A	0.700	0.900	0.028	0.035
A1	0.000	0.100	0.000	0.004
A2	0.700	0.800	0.028	0.031
b1	0.150	0.250	0.006	0.010
b2	0.250	0.325	0.010	0.013
c	0.100	0.200	0.004	0.008
D	1.500	1.700	0.059	0.067
E	0.750	0.850	0.030	0.033
E1	1.450	1.750	0.057	0.069
e	0.500 TYP		0.020 TYP	
e1	0.900	1.100	0.035	0.043
L	0.550 REF		0.022 REF	
L1	0.280	0.440	0.011	0.017
θ	0°	4°	0°	4°

©2010 Alfa-MOS Technology Corp.
 2F, No.80, Sec.1, Cheng Kung Rd., Nan Kang Dist., Taipei City 115, Taiwan (R.O.C.)
 Tel : 886 2) 2651 3928
 Fax : 886 2) 2786 8483
 ©http://www.alfa-mos.com