



## General Description

AFP1033, P-Channel enhancement mode MOSFET, uses Advanced Trench Technology to provide excellent  $R_{DS(ON)}$ , low gate charge.

These devices are particularly suited for low voltage power management, such as smart phone and notebook computer, and low in-line power loss are needed in commercial industrial surface mount applications.

## Features

- -30V/-0.6A,  $R_{DS(ON)} = 750\text{ m}\Omega @ V_{GS} = -10\text{V}$
- -30V/-0.3A,  $R_{DS(ON)} = 950\text{ m}\Omega @ V_{GS} = -4.5\text{V}$
- Low Offset (Error) Voltage
- Low-Voltage Operation
- High-Speed Circuits
- Low Battery Voltage Operation
- SOT-523 package design

## Pin Description ( SOT-523 )

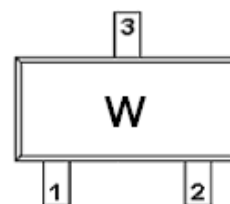
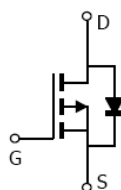
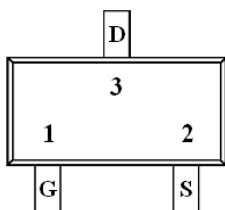

## Application

- Drivers: Relays, Solenoids, Lamps, Hammers, Displays, Memories
- Battery Operated Systems
- Power Supply Converter Circuits
- Load/Power Switching Smart Phones, Pagers

## Pin Define

Pin	Symbol	Description
1	G	Gate
2	S	Source
3	D	Drain

## Ordering Information

Part Ordering No.	Part Marking	Package	Unit	Quantity
AFP1033S52RG	W	SOT-523	Tape & Reel	3000 EA

※ AFP1033S52RG : 7" Tape & Reel ; Pb- Free ; Halogen- Free



**Absolute Maximum Ratings**

(T<sub>A</sub>=25°C Unless otherwise noted)

Parameter	Symbol	Typical	Unit
Drain-Source Voltage	V <sub>DSS</sub>	-30	V
Gate –Source Voltage	V <sub>GSS</sub>	±12	V
Continuous Drain Current(T <sub>J</sub> =150°C)	I <sub>D</sub>	T <sub>A</sub> =25°C	-0.6
		T <sub>A</sub> =70°C	-0.3
Pulsed Drain Current	I <sub>DM</sub>	-1.0	A
Continuous Source Current(Diode Conduction)	I <sub>S</sub>	-0.3	A
Power Dissipation	P <sub>D</sub>	T <sub>A</sub> =25°C	0.27
		T <sub>A</sub> =70°C	0.16
Operating Junction Temperature	T <sub>J</sub>	-55/150	°C
Storage Temperature Range	T <sub>STG</sub>	-55/150	°C

**Electrical Characteristics**

(T<sub>A</sub>=25°C Unless otherwise noted)

Parameter	Symbol	Conditions	Min.	Typ	Max.	Unit
<b>Static</b>						
Drain-Source Breakdown Voltage	V <sub>(BR)DSS</sub>	V <sub>GS</sub> =0V, I <sub>D</sub> =-250uA	-30			V
Gate Threshold Voltage	V <sub>GS(th)</sub>	V <sub>DS</sub> =V <sub>GS</sub> , I <sub>D</sub> =-250uA	-0.7		-1.5	
Gate Leakage Current	I <sub>GSS</sub>	V <sub>DS</sub> =0V, V <sub>GS</sub> =±12V			±100	nA
Zero Gate Voltage Drain Current	I <sub>DSS</sub>	V <sub>DS</sub> =-24V, V <sub>GS</sub> =0V			-1	uA
		V <sub>DS</sub> =-24V, V <sub>GS</sub> =0V T <sub>J</sub> =85°C			-5	
On-State Drain Current	I <sub>D(on)</sub>	V <sub>DS</sub> ≥ 5V, V <sub>GS</sub> =4.5V	0.5			A
Drain-Source On-Resistance	R <sub>DS(on)</sub>	V <sub>GS</sub> =-10V, I <sub>D</sub> =-0.6A		500	750	mΩ
		V <sub>GS</sub> =-4.5V, I <sub>D</sub> =-0.3A		690	950	
Forward Transconductance	g <sub>FS</sub>	V <sub>DS</sub> =-15V, I <sub>D</sub> =-0.5A		1		S
Diode Forward Voltage	V <sub>SD</sub>	I <sub>S</sub> =-0.3A, V <sub>GS</sub> =0V		0.65	1.2	V
<b>Dynamic</b>						
Input Capacitance	C <sub>iss</sub>	V <sub>DS</sub> =-15V, V <sub>GS</sub> =0V f=1MHz		34		pF
Output Capacitance	C <sub>oss</sub>			12		
Reverse Transfer Capacitance	C <sub>rss</sub>			8		
Total Gate Charge	Q <sub>g</sub>	V <sub>DS</sub> =-15V, V <sub>GS</sub> =-4.5V I <sub>D</sub> ≡-0.4A		0.8	1.3	nC
Gate-Source Charge	Q <sub>gs</sub>			0.4		
Gate-Drain Charge	Q <sub>gd</sub>			0.4		
Turn-On Time	t <sub>d(on)</sub>	V <sub>DD</sub> =-15V, R <sub>L</sub> =38Ω I <sub>D</sub> ≡-0.2A, V <sub>GEN</sub> =-4.5V R <sub>G</sub> =1Ω		35	50	ns
	t <sub>r</sub>			20	30	
Turn-Off Time	t <sub>d(off)</sub>			10	20	
	t <sub>f</sub>			10	20	



## Typical Characteristics

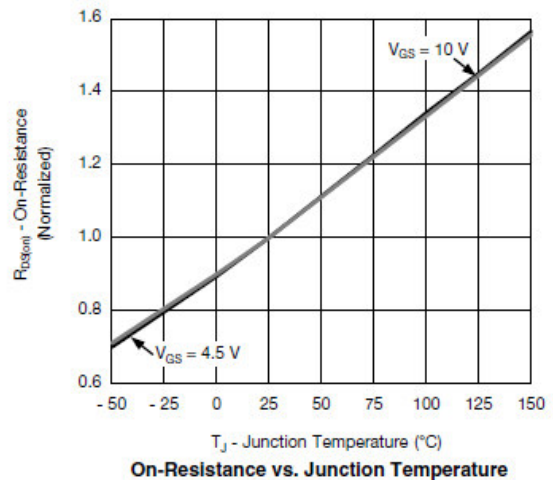
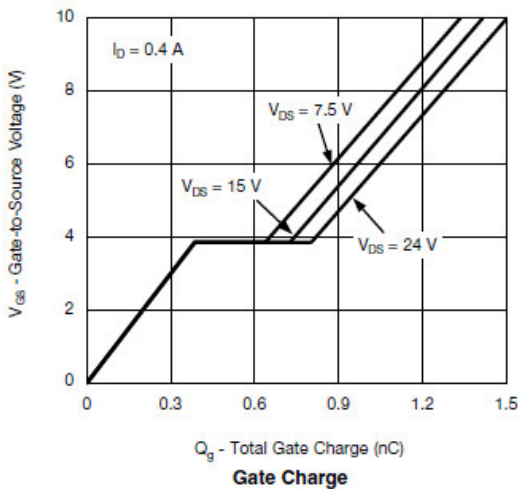
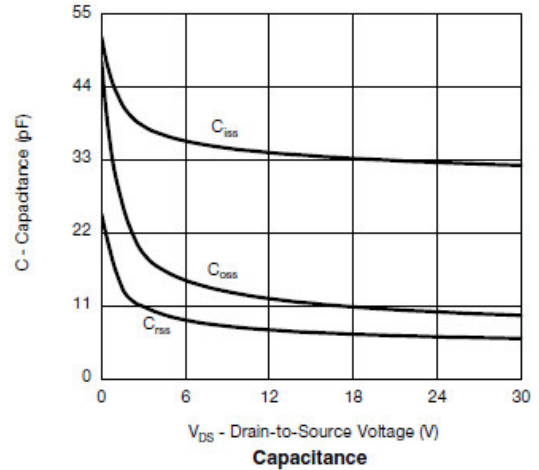
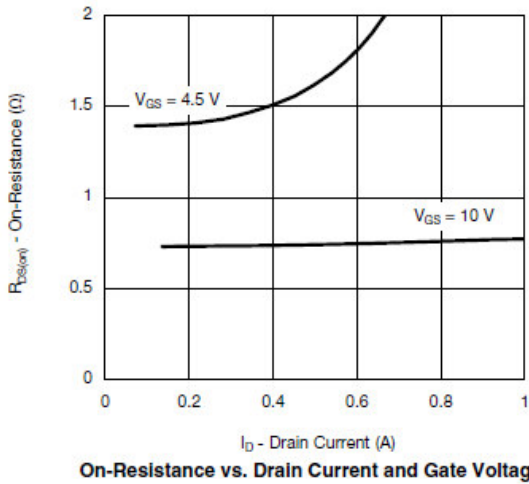
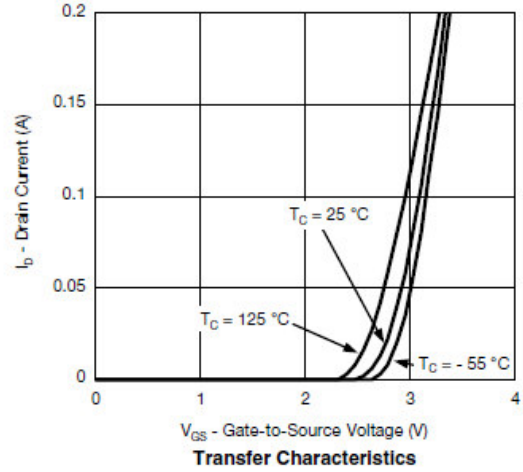
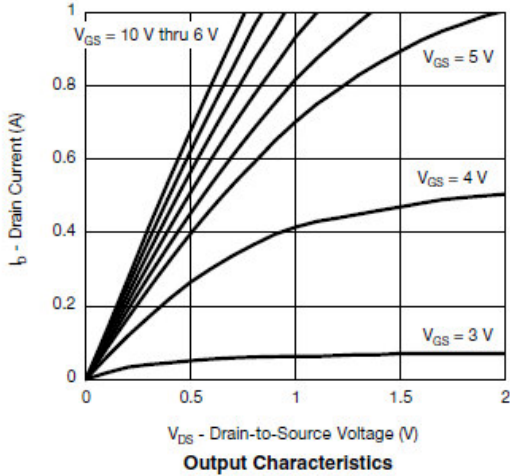



## Typical Characteristics

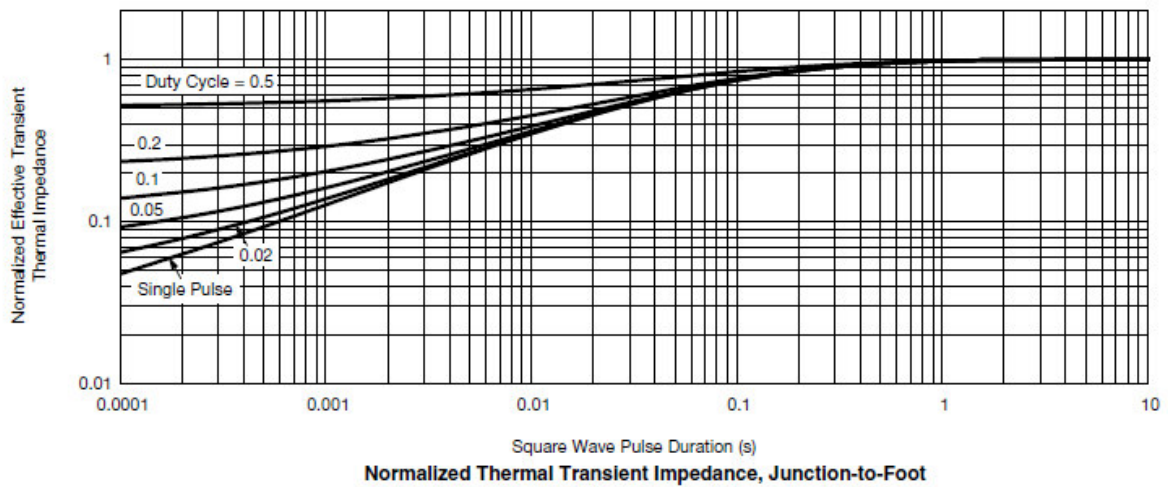
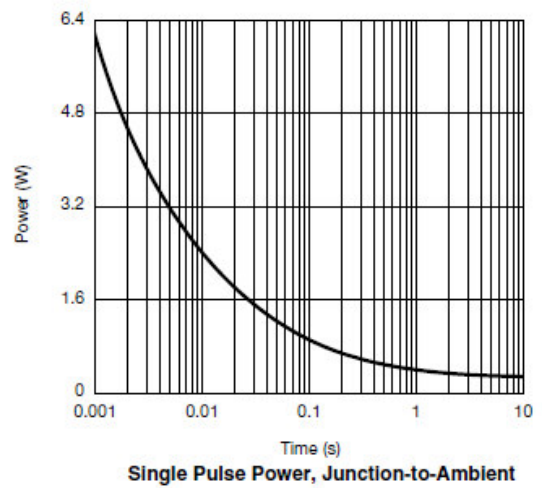
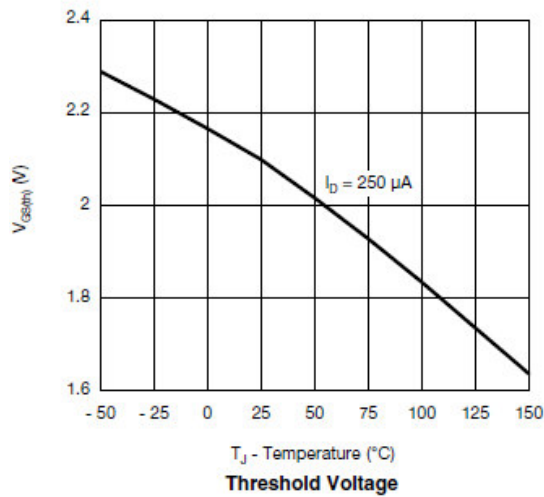
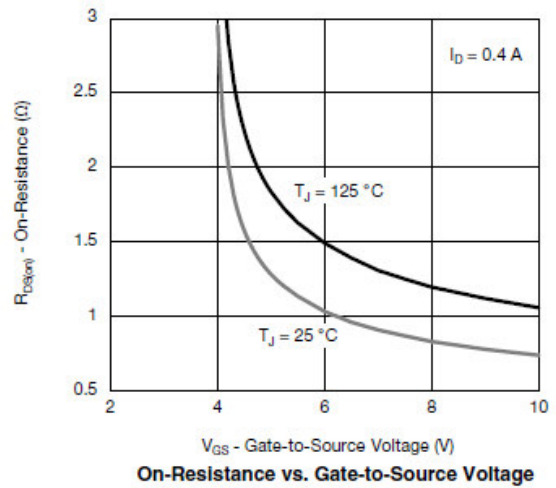
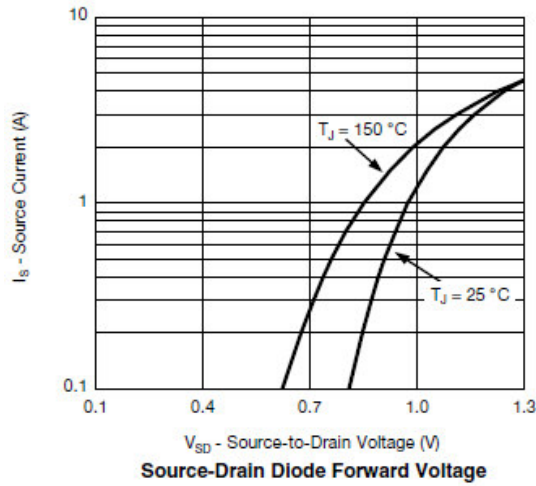



**Typical Characteristics**

Gate Charge Test Circuit & Waveform

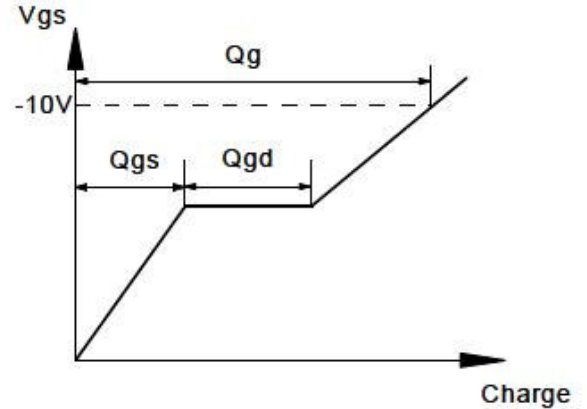
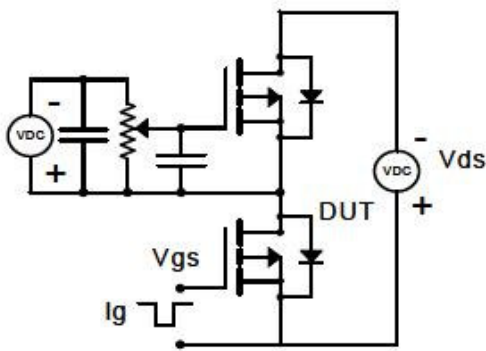

Resistive Switching Test Circuit & Waveforms

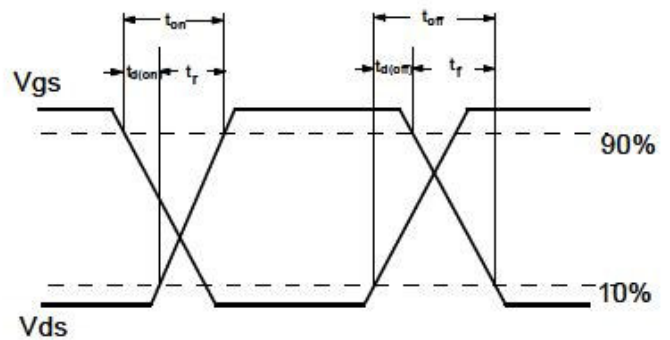
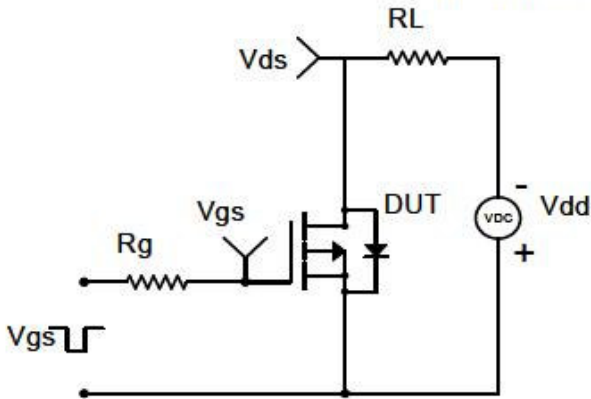

Diode Recovery Test Circuit & Waveforms

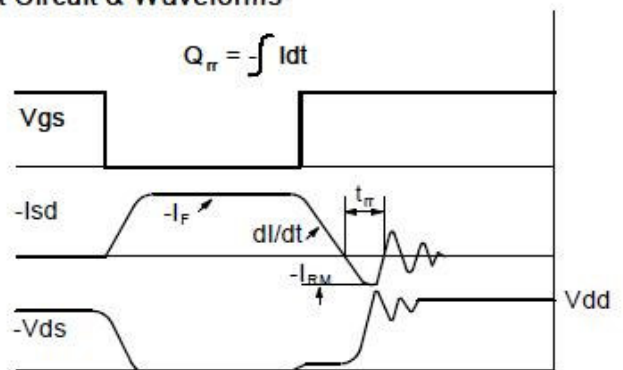
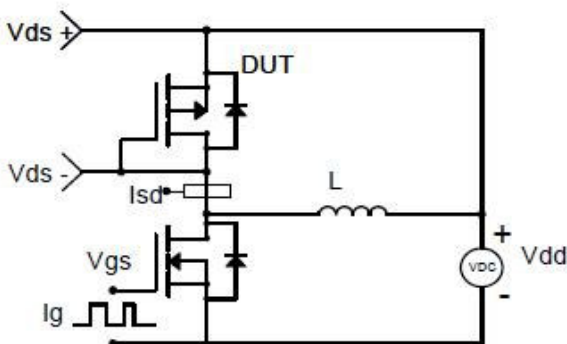



**Package Information ( SOT-523 )**

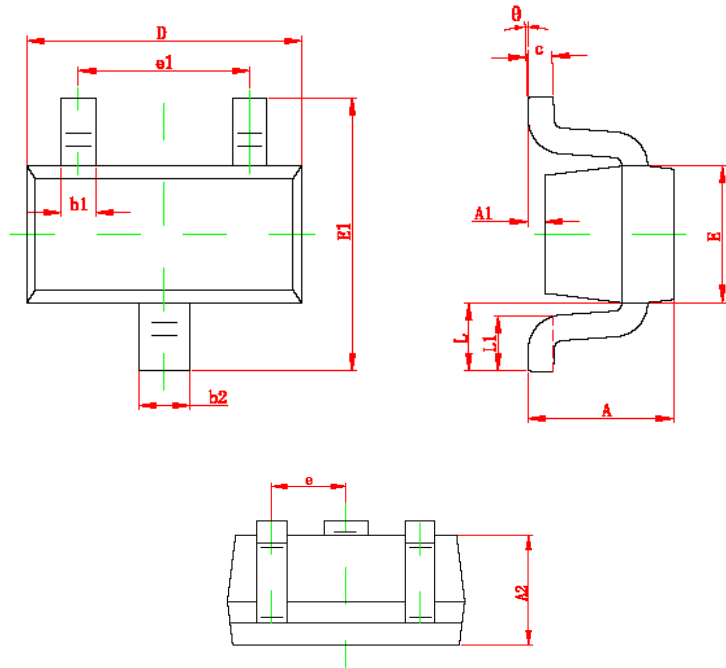

Symbol	Dimensions In Millimeters		Dimensions In Inches	
	Min	Max	Min	Max
A	0.700	0.900	0.028	0.035
A1	0.000	0.100	0.000	0.004
A2	0.700	0.800	0.028	0.031
b1	0.150	0.250	0.006	0.010
b2	0.250	0.325	0.010	0.013
c	0.100	0.200	0.004	0.008
D	1.500	1.700	0.059	0.067
E	0.750	0.850	0.030	0.033
E1	1.450	1.750	0.057	0.069
e	0.500 TYP		0.020 TYP	
e1	0.900	1.100	0.035	0.043
L	0.550 REF		0.022 REF	
L1	0.280	0.440	0.011	0.017
θ	0°	4°	0°	4°

©2010 Alfa-MOS Technology Corp.  
 2F, No.80, Sec.1, Cheng Kung Rd., Nan Kang Dist., Taipei City 115, Taiwan (R.O.C.)  
 Tel : 886 2) 2651 3928  
 Fax : 886 2) 2786 8483  
 ©http://www.alfa-mos.com