



General Description

AFP7619WS, P-Channel enhancement mode MOSFET, uses Advanced Trench Technology to provide excellent $R_{DS(ON)}$, low gate charge.

These devices are particularly suited for low voltage power management, such as smart phone and notebook computer and other battery powered circuits, and low in-line power loss are needed in commercial industrial surface mount applications.

Features

- -30V/-10A, $R_{DS(ON)}=18m\Omega@V_{GS}=-10V$
- -30V/-8A, $R_{DS(ON)}=28m\Omega@V_{GS}=-4.5V$
- Super high density cell design for extremely low $R_{DS(ON)}$
- Exceptional on-resistance and maximum DC current capability
- DFN3X3-8L package design

Pin Description (DFN3X3-8L)

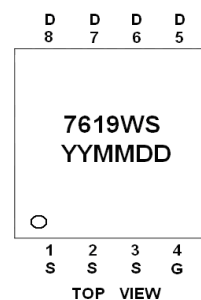
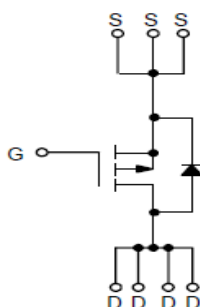
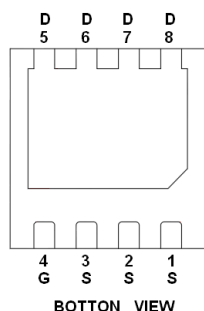

Application

- DC-DC Converter
- POL

Pin Define

Pin	Symbol	Description
1	S	Source
2	S	Source
3	S	Source
4	G	Gate
5	D	Drain
6	D	Drain
7	D	Drain
8	D	Drain

Ordering Information

Part Ordering No.	Part Marking	Package	Unit	Quantity
AFP7619WSFN338RG	7619WS	DFN3X3-8L	Tape & Reel	5000 EA

※ YY year code

※ MM month code

※ DD date code

※ AFP7619WSFN338RG : 13" Tape & Reel ; Pb- Free ; Halogen- Free



Absolute Maximum Ratings

(T_A=25°C Unless otherwise noted)

Parameter	Symbol	Typical	Unit
Drain-Source Voltage	V _{DSS}	-30	V
Gate –Source Voltage	V _{GSS}	±20	V
Continuous Drain Current(T _J =150°C)	I _D	T _A =25°C	-10
		T _A =70°C	-8
Pulsed Drain Current	I _{DM}	-50	A
Continuous Source Current(Diode Conduction)	I _S	-3	A
Power Dissipation	P _D	T _A =25°C	28
		T _A =70°C	18
Operating Junction Temperature	T _J	150	°C
Storage Temperature Range	T _{STG}	-55/150	°C
Thermal Resistance-Junction to Ambient	R _{θJA}	120	°C/W

Electrical Characteristics

(T_A=25°C Unless otherwise noted)

Parameter	Symbol	Conditions	Min.	Typ	Max.	Unit
Static						
Drain-Source Breakdown Voltage	V _{(BR)DSS}	V _{GS} =0V, I _D =-250uA	-30			V
Gate Threshold Voltage	V _{GS(th)}	V _{DS} =V _{GS} , I _D =-250uA	-1.0		-2.0	
Gate Leakage Current	I _{GSS}	V _{DS} =0V, V _{GS} =±25V			±100	nA
Zero Gate Voltage Drain Current	I _{DSS}	V _{DS} =-24V, V _{GS} =0V			-1	uA
		V _{DS} =-24V, V _{GS} =0V T _J =85°C			-30	
On-State Drain Current	I _{D(on)}	V _{DS} ≤ -10V, V _{GS} =-10V	-30			A
		V _{DS} ≤ -5V, V _{GS} =-4.5V	-5			
Drain-Source On-Resistance	R _{DS(on)}	V _{GS} =-10V, I _D =-10A		11	18	mΩ
		V _{GS} =-4.5V, I _D =-8.0A		16	28	
Forward Transconductance	g _{FS}	V _{DS} =-10V, I _D =-9.0A		22		S
Diode Forward Voltage	V _{SD}	I _S =-2.3A, V _{GS} =0V		-0.7	-1.3	V
Dynamic						
Total Gate Charge	Q _g	V _{DS} =-15V, V _{GS} =-4.5V I _D ≡-6.0A		20	30	nC
Gate-Source Charge	Q _{gs}			6		
Gate-Drain Charge	Q _{gd}			10		
Input Capacitance	C _{iss}	V _{DS} =-15V, V _{GS} =0V f=1MHz		1600		pF
Output Capacitance	C _{oss}			350		
Reverse Transfer Capacitance	C _{rss}			300		
Turn-On Time	t _{d(on)}	V _{DD} =-15V, R _L =3Ω I _D ≡-5.0A, V _{GEN} =-10V R _G =1Ω		10	20	ns
	t _r			12	24	
Turn-Off Time	t _{d(off)}			30	45	
	t _f			10	20	



Typical Characteristics

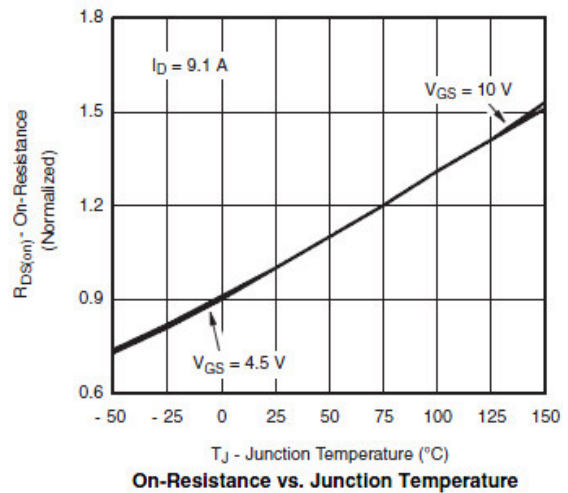
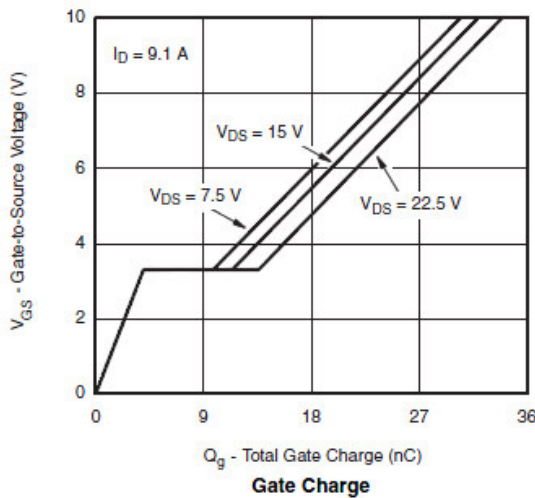
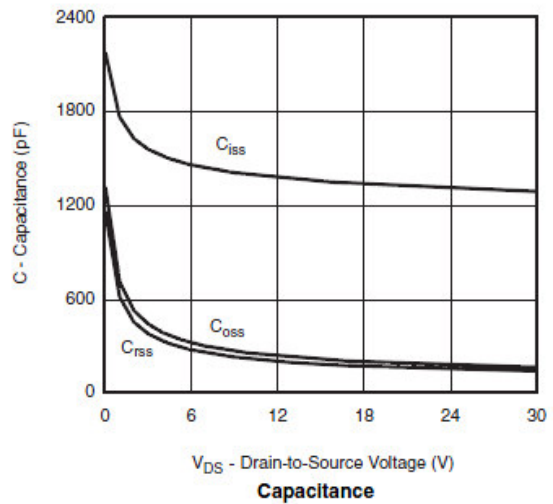
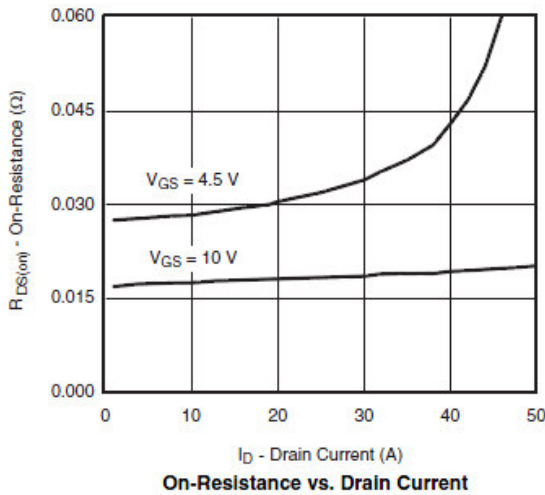
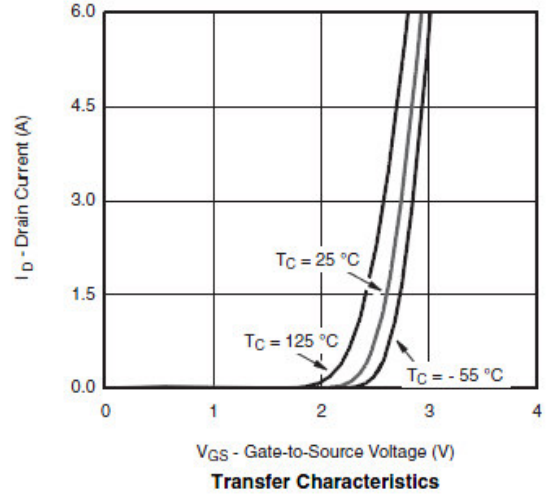
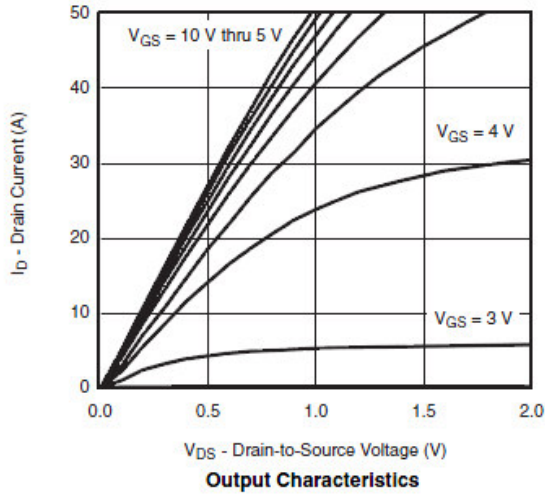



Typical Characteristics

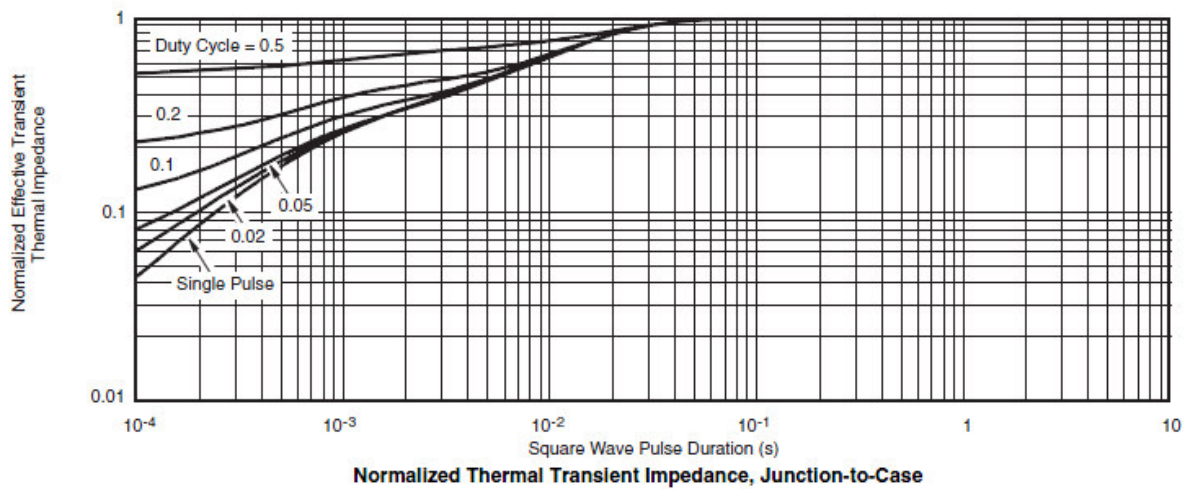
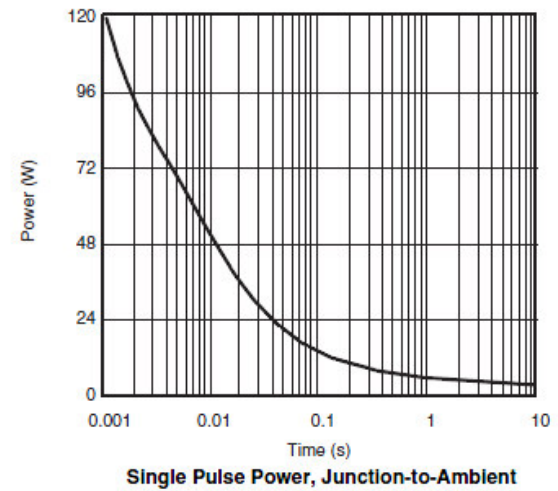
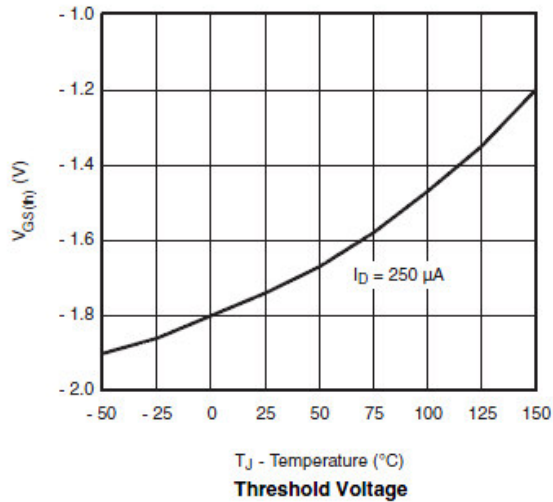
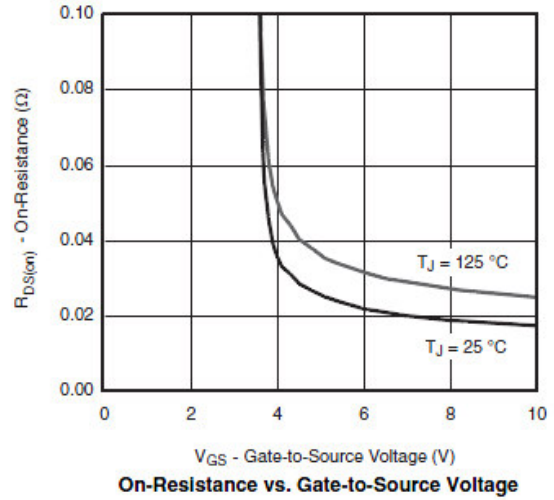
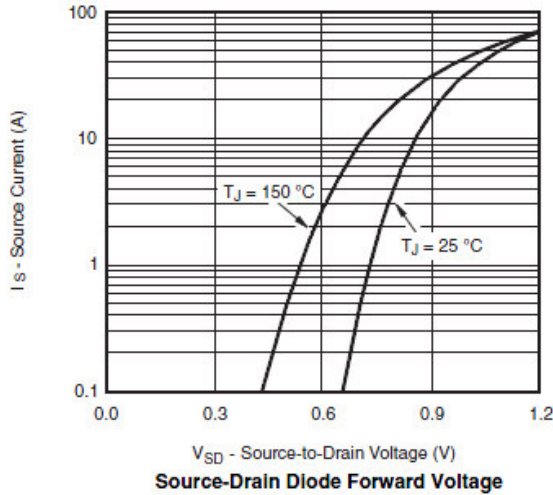



Typical Characteristics

Gate Charge Test Circuit & Waveform



Resistive Switching Test Circuit & Waveforms



Unclamped Inductive Switching Test Circuit & Waveforms





Package Information (DFN3X3-8L)

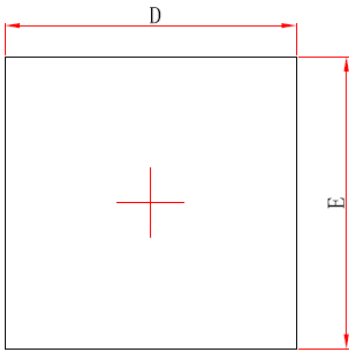

Top View

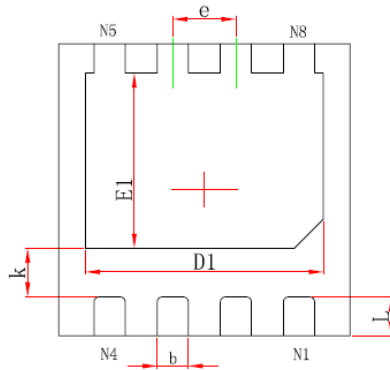

Bottom View

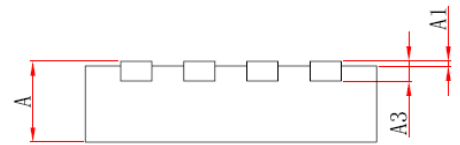

Side View

Symbol	Dimensions In Millimeters		Dimensions In Inches	
	Min.	Max.	Min.	Max.
A	0.800	0.900	0.031	0.035
A1	0.000	0.050	0.000	0.002
A3	0.203REF.		0.008REF.	
D	2.924	3.076	0.115	0.121
E	2.924	3.076	0.115	0.121
D1	2.350	2.550	0.093	0.100
E1	1.700	1.900	0.067	0.075
k	0.450	0.550	0.018	0.022
b	0.270	0.370	0.011	0.015
e	0.650TYP.		0.026TYP.	
L	0.324	0.476	0.013	0.019

©2010 Alfa-MOS Technology Corp.
2F, No.80, Sec.1, Cheng Kung Rd., Nan Kang Dist., Taipei City 115, Taiwan (R.O.C.)
Tel : 886 2) 2651 3928
Fax : 886 2) 2786 8483
©http://www.alfa-mos.com